

OPERSAN

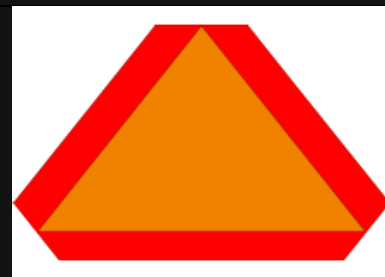

TRIANGLE ECE 69 (Class 1)

STANDARD	
Trade Mark	: OPERSAN®
Appropriateness	: TSE-ECE 69
Turkish Code	: E37
Confirmation Code	: 00 00003
Items	: H14
Dimension	: 365*365 mm
Structural characteristics	: RF
COLOUR STANDARD	
Night View	: Reflective
Day View	: Reflective/Fluorescent
Using Place	: For Tractor
Mounting way	: Horizontal/Vertical
warranty	: 2 Years
certificate of warranty	: 16.07.2004 / 020443

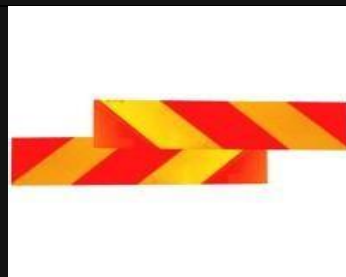
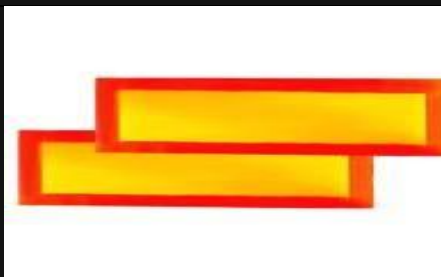
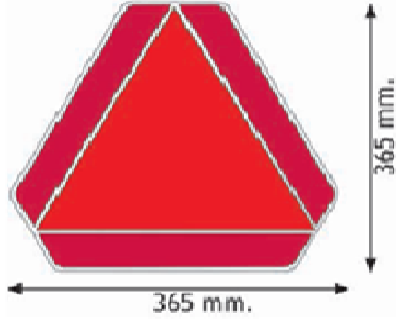

CODE	CATEGORY	MATERIAL	THICKNESS	DIMENSION	1 PACKAGE
R0101	ECE 69 RF	ALUMINUM	0,80	365X365	10 Set
R0102	ECE 69 RF	ALUMINUM	1,00	365X365	10 Set
R0103	ECE 69 RF	ALUMINUM	1,20	365X365	10 Set
R0104	ECE 69 RF	ALUMINUM	2,00	365X365	10 Set
R0105	ECE 69 RF	ADHESIVE		365X365	50 Set

TRIANGLE ECE 69 (Class 2)

STANDARD	
Trade Mark	: OPERSAN®
Appropriateness	: TSE-ECE 69
Turkish Code	: E37
Confirmation Code	: 00 00003
Items	: H14
Dimension	: 365*365 mm
Structural characteristics	: RR
COLOUR STANDARD	
Night View	: Full Performance Reflective
Day View	: Reflective/Reflective
Using Place	: For Tractor
Mounting way	: Horizontal/Vertical
warranty	: 2 Years
certificate of warranty	: 16.07.2004 / 020443

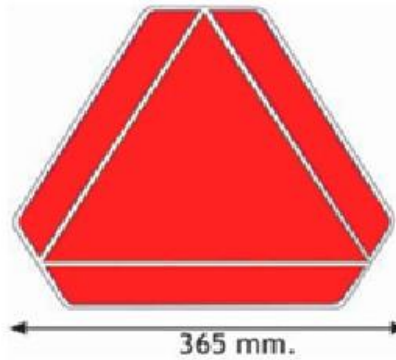

CODE	CATEGORY	MATERIAL	THICKNESS	DIMENSION	1 PACKAGE
R0201	ECE 69 RR	ALUMINUM	0,80	365X365	10 SET
R0202	ECE 69 RR	ALUMINUM	1,00	365X365	10 SET
R0203	ECE 69 RR	ALUMINUM	1,20	365X365	10 SET
R0204	ECE 69 RR	ALUMINUM	2,00	365X365	10 SET
R0205	ECE 69 RR	ADHESIVE		365X365	50 SET

REAR TRUCK MARKER BOARDS ECE 70 (Class 1)

STANDARD	
Trade Mark	: OPERSAN®
Appropriateness	: TSE-ECE 69
Turkish Code	: E37
Confirmation Code	: 00 00003
Items	: H14
Dimension	: 365*365 mm
Structural characteristics	: RF
COLOUR STANDARD	
Night View	: Reflective
Day View	: Reflective/Fluorescent
Using Place	: For Tractor
Mounting way	: Horizontal/Vertical
warranty	: 2 Years
certificate of warranty	: 16.07.2004 / 020443

CODE	CATEGORY	MATERIAL	THICKNESS	DIMENSION	1 PACKAGE
K0101	ECE 70 RF	ALUMINUM	0,80	565X132	10 SET
K0102	ECE 70 RF	ALUMINUM	1,00	565X132	10 SET
K0103	ECE 70 RF	ALUMINUM	1,20	565X132	10 SET
K0104	ECE 70 RF	ALUMINUM	2,00	565X132	10 SET
K0105	ECE 70 RF	ADHESIVE		565X132	50 SET

REAR TRUCK MARKER BOARDS ECE 70 (Class 3)

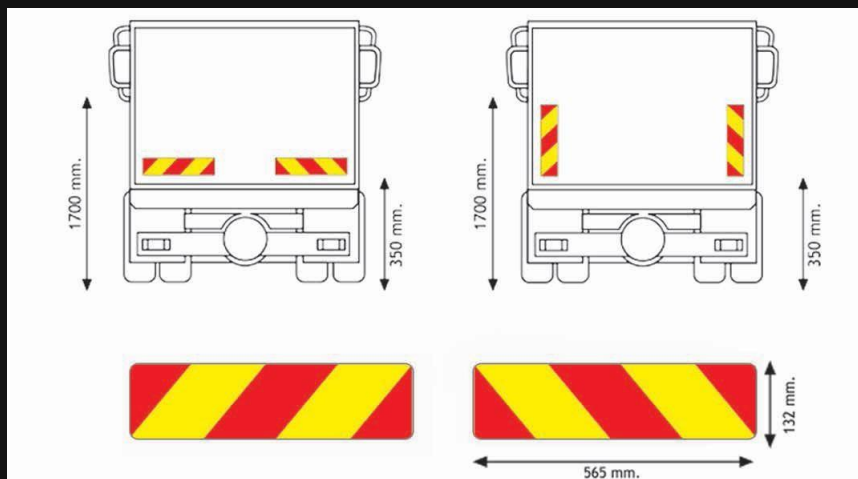

CODE	CATEGORY	MATERIAL	THICKNESS	DIMENSION	1 PACKAGE
K0201	ECE 70 RR	ALUMINUM	0,80	565X132	10 SET
K0202	ECE 70 RR	ALUMINUM	1,00	565X132	10 SET
K0203	ECE 70 RR	ALUMINUM	1,20	565X132	10 SET
K0204	ECE 70 RR	ALUMINUM	2,00	565X132	10 SET
K0205	ECE 70 RR	ADHESIVE		565X132	50 SET

REAR TRUCK MARKER BOARDS ECE 70 (Class 1-3)

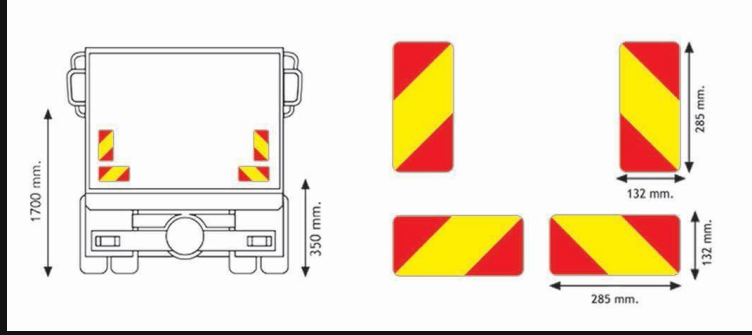

1 SET = 2 RIGHT 2 LEFT

CODE	CATEGORY	MATERIAL	THICKNESS	DIMENSION	1 PACKAGE
K0106	ECE 70 RF	ALUMINUM	0,80	285X132	10 SET
K0107	ECE 70 RF	ALUMINUM	1,00	285X132	10 SET
K0108	ECE 70 RF	ALUMINUM	1,20	285X132	10 SET
K0109	ECE 70 RF	ALUMINUM	2,00	285X132	10 SET
K0110	ECE 70 RF	ADHESIVE		285X132	50 SET
K0206	ECE 70 RR	ALUMINUM	0,80	285X132	10 SET
K0207	ECE 70 RR	ALUMINUM	1,00	285X132	10 SET
K0208	ECE 70 RR	ALUMINUM	1,20	285X132	10 SET
K0209	ECE 70 RR	ALUMINUM	2,00	285X132	10 SET
K0210	ECE 70 RR	ADHESIVE		285X132	50 SET

REAR TRUCK MARKER BOARDS ECE 70 (Class 1-3)

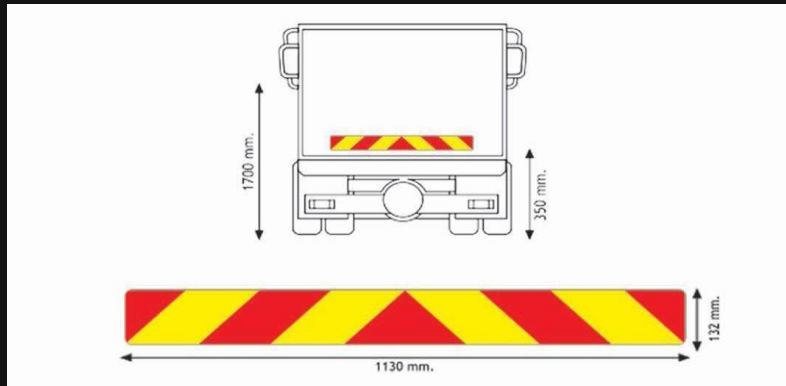

KOD NO	KATAGORİ	MATERYAL	KALINLIK	EBAT	1 KOLİ
K0106	ECE 70 RF	ALUMINUM	0,80	285X132	10 SET
K0107	ECE 70 RF	ALUMINUM	1,00	285X132	10 SET
K0108	ECE 70 RF	ALUMINUM	1,20	285X132	10 SET
K0109	ECE 70 RF	ALUMINUM	2,00	285X132	10 SET
K0110	ECE 70 RF	ADHESIVE		285X132	50 SET
K0206	ECE 70 RR	ALUMINUM	0,80	285X132	10 SET
K0207	ECE 70 RR	ALUMINUM	1,00	285X132	10 SET
K0208	ECE 70 RR	ALUMINUM	1,20	285X132	10 SET
K0209	ECE 70 RR	ALUMINUM	2,00	285X132	10 SET
K0210	ECE 70 RR	ADHESIVE		285X132	50 SET

REAR TRUCK MARKER BOARDS ECE 70

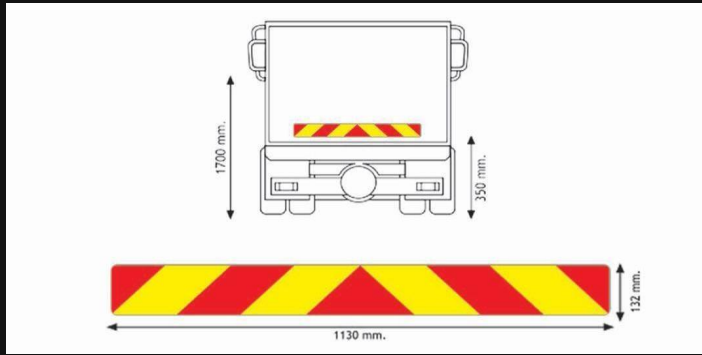

CODE	CATEGORY	MATERIAL	THICKNESS	DIMENSION	1 PACKAGE
K0111	ECE 70 RF	ALUMINUM	0,80	1130X132	10 SET
K0112	ECE 70 RF	ALUMINUM	1,00	1130X132	10 SET
K0113	ECE 70 RF	ALUMINUM	1,20	1130X132	10 SET
K0114	ECE 70 RF	ALUMINUM	2,00	1130X132	10 SET
K0115	ECE 70 RF	ADHESIVE		1130X132	50 SET
K0211	ECE 70 RR	ALUMINUM	0,80	1130X132	10 SET
K0212	ECE 70 RR	ALUMINUM	1,00	1130X132	10 SET
K0213	ECE 70 RR	ALUMINUM	1,20	1130X132	10 SET
K0214	ECE 70 RR	ALUMINUM	2,00	1130X132	10 SET
K0215	ECE 70 RR	ADHESIVE		1130X132	50 SET

REAR TRAILER MARKER BOARDS ECE 70 (Class 2)

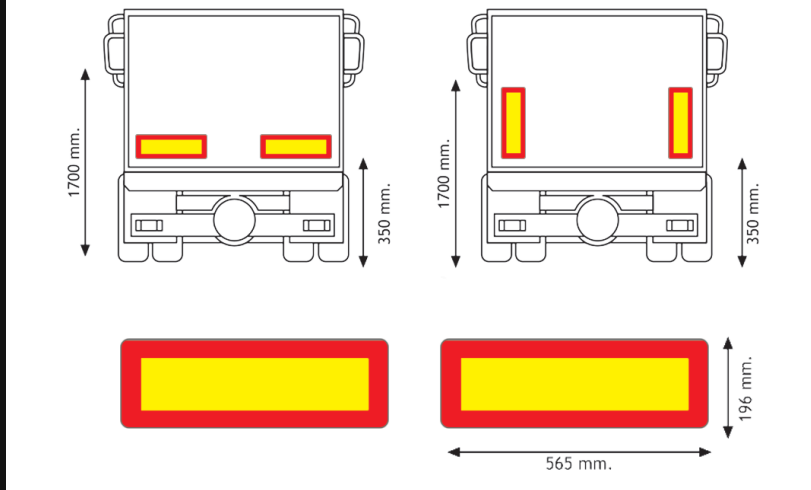

CODE	CATEGORY	MATERIAL	THICKNESS	DIMENSION	1 PACKAGE
T0101	ECE 70 RF	ALUMINUM	0,80	565X196	10 SET
T0102	ECE 70 RF	ALUMINUM	1,00	565X196	10 SET
T0103	ECE 70 RF	ALUMINUM	1,20	565X196	10 SET
T0104	ECE 70 RF	ALUMINUM	2,00	565X196	10 SET
T0105	ECE 70 RF	ADHESIVE		565X196	50 SET
CODE	CATEGORY	MATERIAL	THICKNESS	DIMENSION	1 PACKAGE
T0201	ECE 70 RR	ALUMINUM	0,80	565X196	10 SET
T0202	ECE 70 RR	ALUMINUM	1,00	565X196	10 SET
T0203	ECE 70 RR	ALUMINUM	1,20	565X196	10 SET
T0204	ECE 70 RR	ALUMINUM	2,00	565X196	10 SET
T0205	ECE 70 RR	ADHESIVE		565X196	50 SET

REAR TRAILER MARKER BOARDS ECE 70 (Class 2)

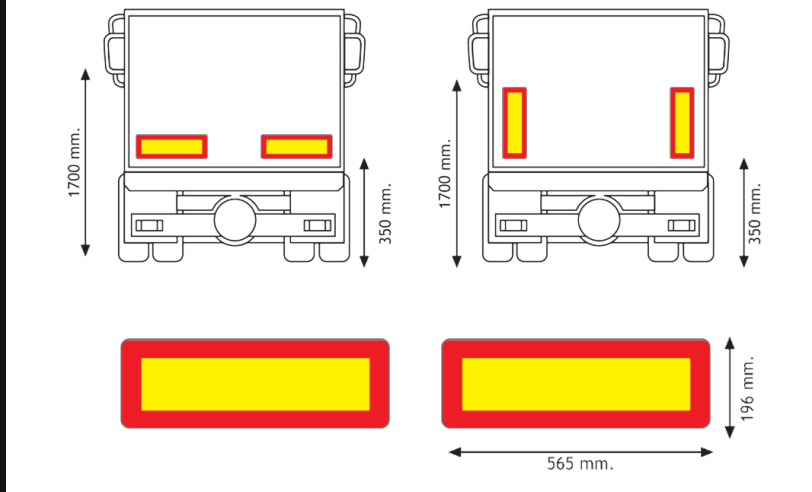

REAR TRAILER MARKER BOARDS ECE 70 (Class 2-4)

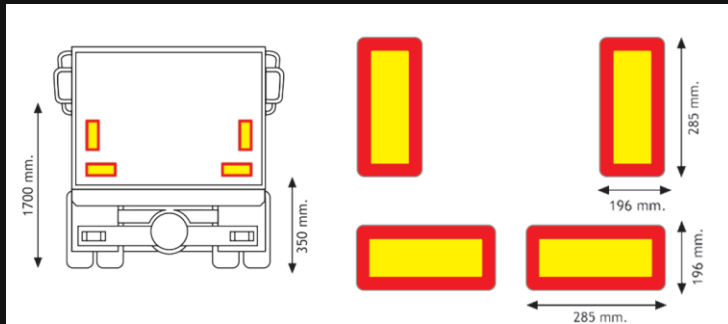

1 Set = 2 Right 2 Left

CODE	CATEGORY	MATERIAL	THICKNESS	DIMENSION	1 PACKAGE
T0106	ECE 70 RF	ALUMINUM	0,80	285X196	10 SET
T0107	ECE 70 RF	ALUMINUM	1,00	285X196	10 SET
T0108	ECE 70 RF	ALUMINUM	1,20	285X196	10 SET
T0109	ECE 70 RF	ALUMINUM	2,00	285X196	10 SET
T0110	ECE 70 RF	ADHESIVE		285X196	50 SET
T0206	ECE 70 RR	ALUMINUM	0,80	285X196	10 SET
T0207	ECE 70 RR	ALUMINUM	1,00	285X196	10 SET
T0208	ECE 70 RR	ALUMINUM	1,20	285X196	10 SET
T0209	ECE 70 RR	ALUMINUM	2,00	285X196	10 SET
T0210	ECE 70 RR	ADHESIVE		285X196	50 SET

REAR TRAILER MARKER BOARDS ECE 70 (Class 2-4)

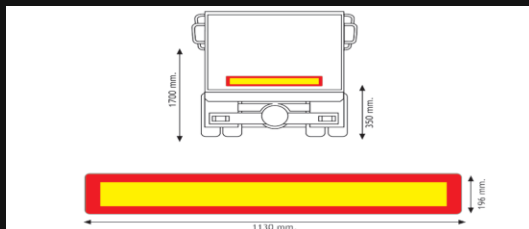

CODE	CATEGORY	MATERIAL	THICKNESS	DIMENSION	1 PACKAGE
T0111	ECE 70 RF	ALUMINUM	0,80	1130X196	10 SET
T0112	ECE 70 RF	ALUMINUM	1,00	1130X196	10 SET
T0113	ECE 70 RF	ALUMINUM	1,20	1130X196	10 SET
T0114	ECE 70 RF	ALUMINUM	2,00	1130X196	10 SET
T0115	ECE 70 RF	ADHESIVE		1130X196	50 SET
T0211	ECE 70 RR	ALUMINUM	0,80	1130X196	10 SET
T0212	ECE 70 RR	ALUMINUM	1,00	1130X196	10 SET
T0213	ECE 70 RR	ALUMINUM	1,20	1130X196	10 SET
T0214	ECE 70 RR	ALUMINUM	2,00	1130X196	10 SET
T0215	ECE 70 RR	ADHESIVE		1130X196	50 SET

FOR TRUCK AND TRAILER (Class 5)

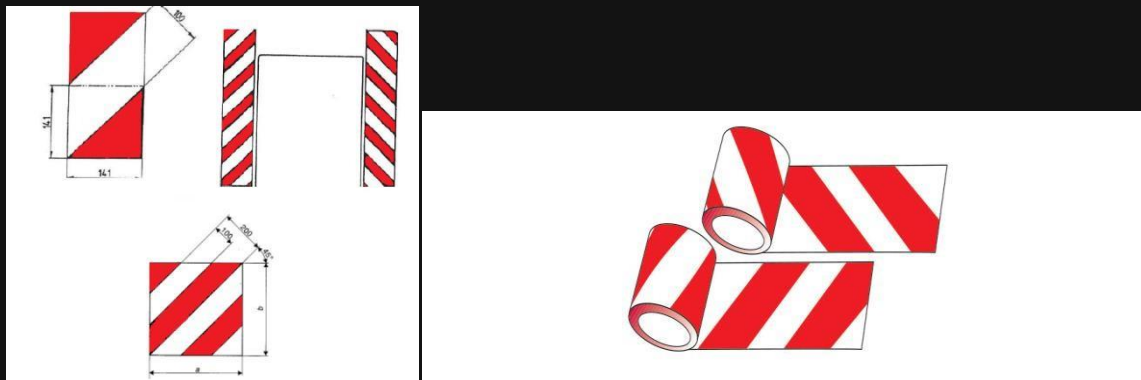

Heavy motor vehicles the installation of rear marking plates for heavy motor vehicles according to the provisions of this annex is required for vehicles of categories N2 with a maximum mass exceeding 7,5 tonnes and N3 with the exception of tractors for semi-trailers, and for articulated buses of classes II and III.

CODE	CATEGORY	MATERIAL	THICKNESS	QNTY	DIMENSION	1 PACKAGE
B0201	ECE 70	ADHESIVE		Right-Left	141 mmX20 Meter	1 SET
B0202	ECE 70	ADHESIVE		Right-Left	141 mmX25 Meter	1 SET
B0203	ECE 70	ADHESIVE		Right-Left	141 mmX50 Meter	1 SET
B0204	ECE 70	ALUMINUM	0,80	Right-Left	141 mmX565 mm	10 SET
B0205	ECE 70	ALUMINUM	0,80	Right-Left	141 mmX705 mm	10 SET
B0206	ECE 70	ALUMINUM	1,00	Right-Left	141 mmX565 mm	10 SET
B0207	ECE 70	ALUMINUM	1,00	Right-Left	141 mmX705 mm	10 SET
B0208	ECE 70	ALUMINUM	1,20	Right-Left	141 mmX565 mm	10 SET
B0209	ECE 70	ALUMINUM	1,20	Right-Left	141 mmX705 mm	10 SET
B0210	ECE 70	ALUMINUM	2,00	Right-Left	141 mmX565 mm	10 SET
B0211	ECE 70	ALUMINUM	2,00	Right-Left	141 mmX705 mm	10 SET

REFLECTIVE TAPE ECE 104



CODE	CATEGORY	COLOUR	LENGTH	WIDTH	1 PACKAGE
BS01	ECE 104	YELLOW	50 METER	50 MM	10 PIECE

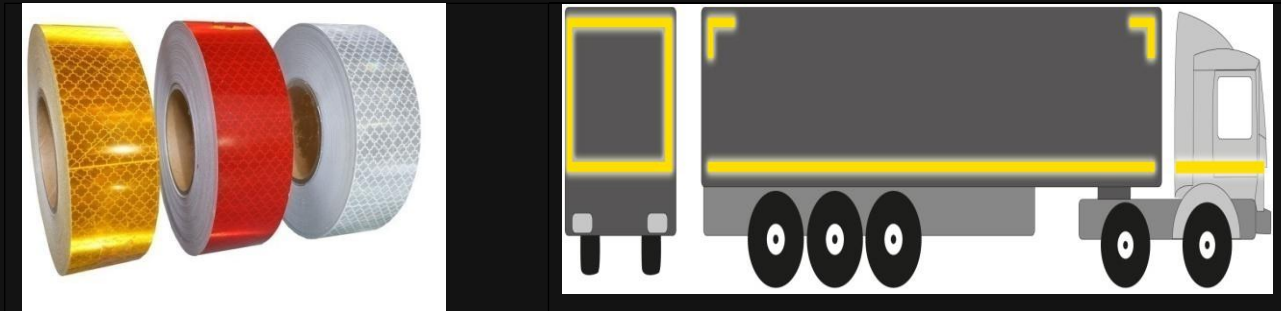

CODE	CATEGORY	COLOUR	LENGTH	WIDTH	1 PACKAGE
BK01	ECE 104	RED	50 METER	50 MM	10 PIECE

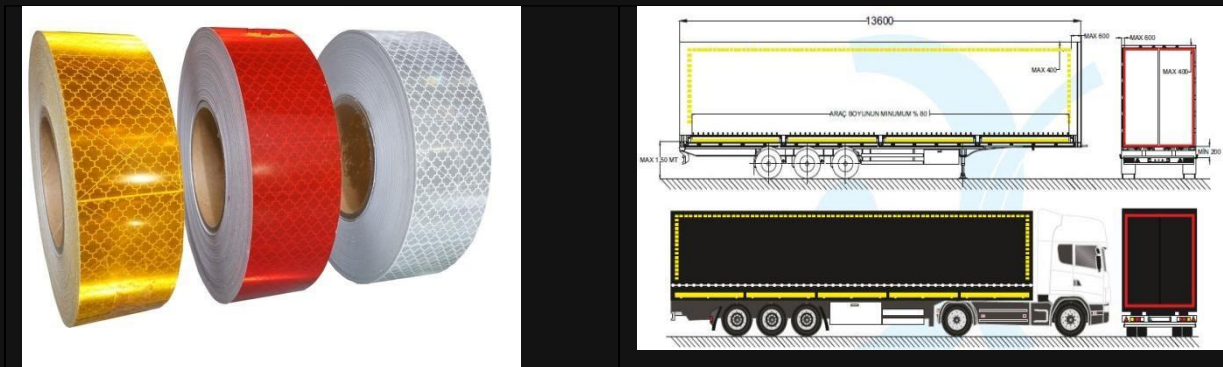

CODE	CATEGORY	COLOUR	LENGTH	WIDTH	1 PACKAGE
BB01	ECE 104	WHITE	50 METER	50 MM	10 PIECE

REFLECTIVE TAPE FOR RIGID SURFACE

CODE	CATEGORY	COLOUR	LENGTH	WIDTH	1 PACKAGE
BSP01	ECE 104	YELLOW	50 METER	50 MM	10 PIECES
BKP01	ECE 104	RED	50 METER	50 MM	10 PIECES
BBP01	ECE 104	WHITE	50 METER	50 MM	10 PIECES

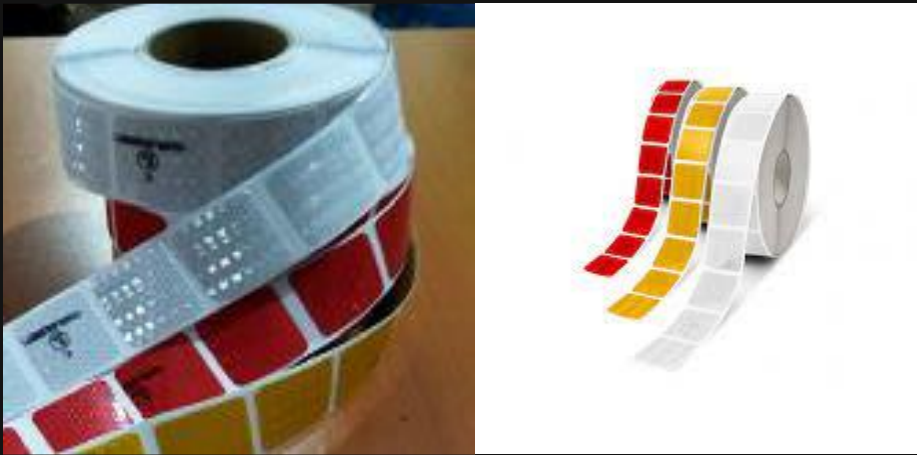

SPEED LIMIT DISCS FOR VEHICLES

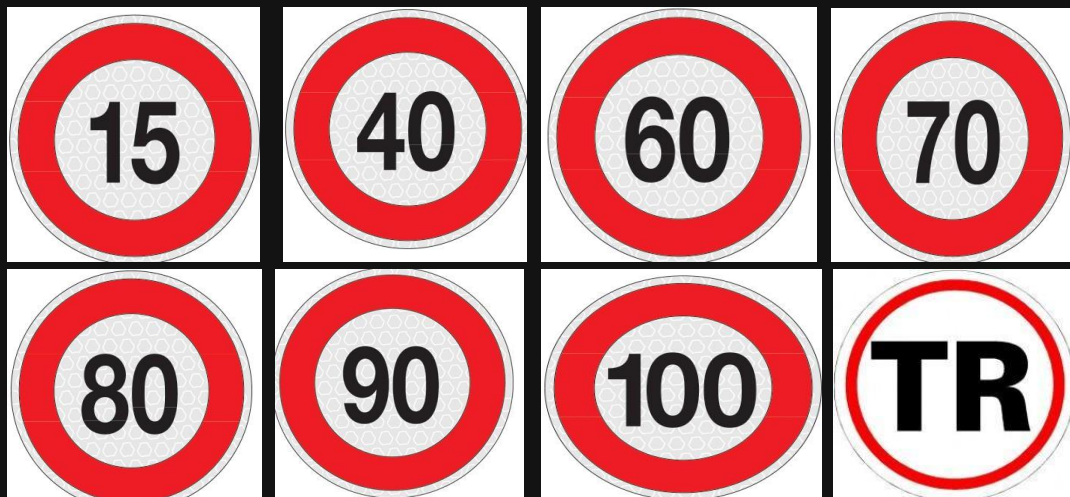

T0307	100	ADHESIVE	Ø 100	100 PIECE
T0308	TIR	ADHESIVE	Ø 100	100 PIECE

CODE	SPEED/KM	MATERIAL	Ø MM	THICKNESS	1 PACKAGE
E0401	15	ALUMINUM	Ø 200	0,80	10 PIECE
E0402	40	ALUMINUM	Ø 200	0,80	10 PIECE
E0403	60	ALUMINUM	Ø 200	0,80	10 PIECE
T0404	70	ALUMINUM	Ø 200	0,80	10 PIECE
T0405	80	ALUMINUM	Ø 200	0,80	10 PIECE
T0406	90	ALUMINUM	Ø 200	0,80	10 PIECE
T0407	100	ALUMINUM	Ø 200	0,80	10 PIECE
T0408	TIR	ALUMINUM	Ø 200	0,80	10 PIECE
T0501	15	ALUMINUM	Ø 100	0,80	10 PIECE
T0502	40	ALUMINUM	Ø 100	0,80	10 PIECE
T0503	60	ALUMINUM	Ø 100	0,80	10 PIECE
T0504	70	ALUMINUM	Ø 100	0,80	10 PIECE
T0505	80	ALUMINUM	Ø 100	0,80	10 PIECE
T0506	90	ALUMINUM	Ø 100	0,80	10 PIECE
T0507	100	ALUMINUM	Ø 100	0,80	10 PIECE
T05 08	TIR	ALUMINUM	Ø 100	0,80	10 PIECE

CONVOI AGRICOLE



CODE	MATERIAL	DIMENSION/mm	1 PACKAGE
C0201	ALUMINUM	1900X250X1	10 PEICE



CODE	MATERIAL	DIMENSION/mm	REFLEX	1 PACKAGE
C0202	ALUMINUM	1200X400X1	A SIDE	10 PIECE
C0203	ALUMINUM	1200X400X1	DOUBLE SIDE	10 PIECE

CONVOI EXCEPTIONNEL

CODE	MATERIAL	DIMENSION/mm	REFLEX	1 PACKAGE
C0204	ALUMINUM	920X150X1	A SIDE	10 PEICE

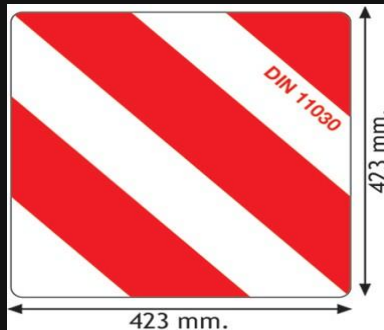

CODE	MATERIAL	DIMENSION/mm	REFLEX	1 PACKAGE
C0205	ALUMINUM	730X300X1	A SIDE	10 PIECE
C0206	ALUMINUM	730X300X1	DOUBLE SIDE	10 PIECE

DIN 11030

CODE	MATERIAL	DIMENSION/mm	REFLEX	1 PACKAGE
D0201	ALUMINUM	423X423X0,80	RIGHT-LEFT	10 PIECE

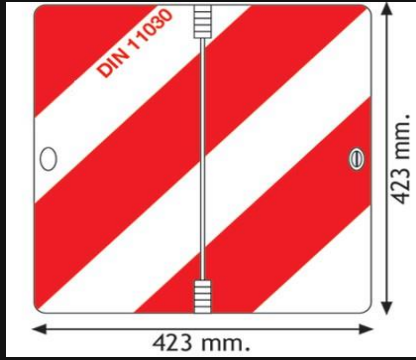

CODE	MATERIAL	DIMENSION/mm	REFLEX	1 PACKAGE
D0202	ALUMINUM	423X423X0,80	RIGHT-LEFT	10 PIECE

TRAILER PANELS



CODE	MATERIAL	DIMENSION/mm	1 PACKAGE
L0201	ALUMINUM	400X250X1	10 PIECE



CODE	MATERIAL	DIMENSION/mm	1 PACKAGE
L0202	ALUMINUM	400X250X1	10 PIECE

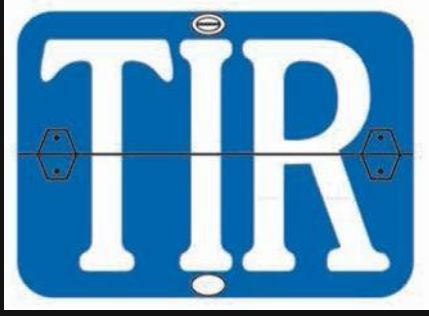

CODE	MATERIAL	DIMENSION/mm	1 PACKAGE
L0203	ALUMİNYUM	400X250X1	10 PIECE

LONG VEHICLE

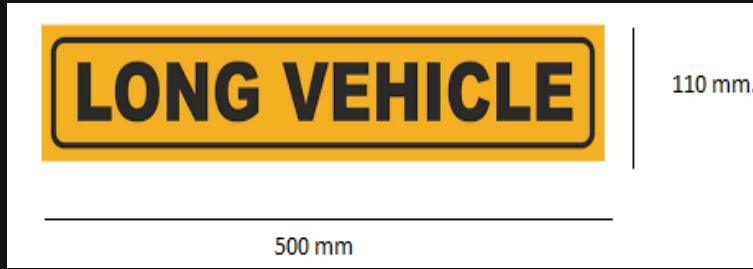

CODE	MATERIAL	DIMENSION/mm	1 PACKAGE
L0204	ALUMINUM	110x500x0,80	20 PIECE
L0205	ADHESIVE	110X500	50 PIECE

A.D.R GROUP



Special order acceptable

HAZARDS LABEL



WARNING PANELS FOR DANGEROUS GOODS

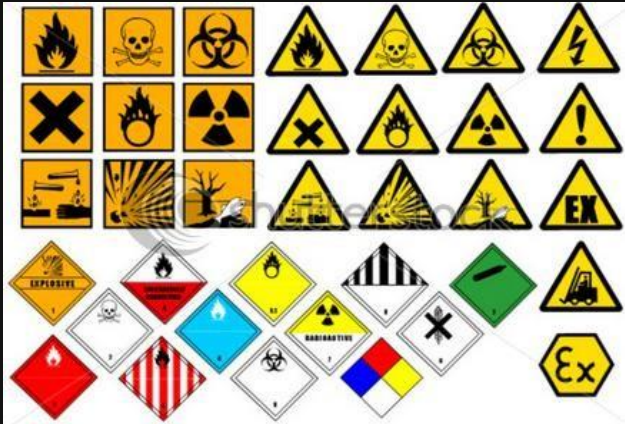

www.opersan.com

opersan@gmail.com

ROAD TRAFFIC SIGNS



ROAD BARRIERS



Special order acceptable

OPERSAN OTOMOTIV LTD ŐTİ

DUAÇINARI MH BEŐİK ÇIKAMAZI SK NO:9/A Z:1

YILDIRIM/ BURSA/ TÜRKiYE

www.opersan.com.tr www.opersan.com

opersan@gmail.com info@opersan.com

WhatsApp :+90 05557192775